

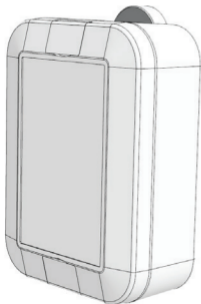

**Quick Start
GUIDE**



Acceler'O
50-70-197

1 Démarrer Start

Vue de côté
Side view



Vue face
Front view

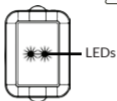

 Provisionner l'appareil sur votre réseau LoRaWAN® avec les clés mises à dispositions sur la plateforme sécurisée.

Provision the device on your LoRaWAN® network with the keys available on the secure platform.

ON :

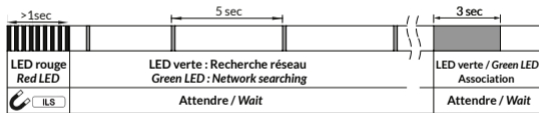

OFF :

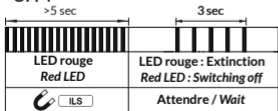

Vidéo / Video :
ON - OFF



<https://www.wattec.fr/assistance/tutoriels-video/>

2

Installation Setting up

Attention aimant de forte puissance (Pacemaker, doigt pincé...)

Caution strong magnet (Pacemaker, pinched finger...)

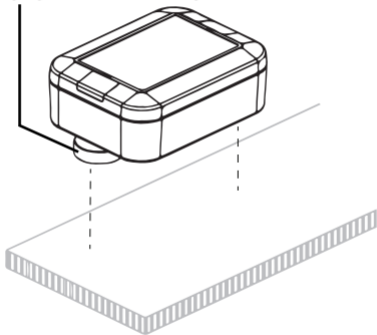

- Déposer délicatement le TAB sur la surface métallique horizontale
Prévoir une surface métallique bien plane et propre
- *Carefully place the TAB on the horizontal metal surface
Make sure the metal surface is flat and clean*

3

Propagation radioélectrique *Radio propagation*

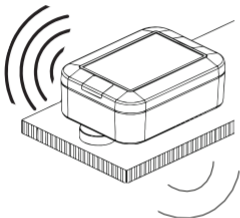

Eviter les obstacles pour une meilleure propagation radio.

Avoiding obstacles for better radio propagation.

Vérifier la couverture radio avec le Netw'O.

Check the radio coverage with the Netw'O.

**4**

Caractéristiques *Characteristics*

Référence / Reference	50-70-197
Classe / Class	A
Niveau de puissance / Power Level	+14 dBm
Mesures / Measures :	Accélération / Acceleration
Antenne / Antenna	Interne / Internal
Matériaux du boîtier / Casing materials	ASA UL94 HB
Indice de protection / IP rating	IP67



SITE SUPPORT

<https://support.watteco.com/>



CERTIFICATIONS

Watteco représenté par JC LE BLEIS, déclare que l'équipement radioélectrique du type 50-70-197 est conforme à la directive 2014/53/UE (RED). Le texte complet de la déclaration UE de conformité est disponible à l'adresse internet suivante: <https://www.watteco.fr/assistance/centre-de-telechargement/>

Watteco represented by JC LE BLEIS, declares that the radio equipment type 50-70-197 is in conformity with Directive 2014/53/EU (RED) and UKCA. The full text of the EU and UKCA Declaration of Conformity is available at the following web address: <https://www.watteco.com/assistance/download-center/>





WATTECO

IoT device manufacturer

**Merci d'avoir choisi
les produits WATTECO**

*Thanks for choosing
WATTECO devices*

